

Hurray for Hexis

Featuring *Slow & Steady* by Tula Pink

Try your hand (literally) at English paper piecing—a portable handwork project you can take anywhere. The result? A bright and colorful quilt for snuggling or hanging on the wall.

Collection:	Slow & Steady by Tula Pink
Technique:	English paper piecing
Skill Level:	Intermediate
Crafting Time:	Longer term*
Finished Size:	40" x 44" (101.60cm x 111.76cm)

*Crafting time based on intermediate skill level

Project designed by Tula Pink

Fabric Requirements

DESIGN	COLOR	ARTICLE CODE	YARDAGE
(A) Designer Essentials Solids	Amazon	CSFSESS.AMAZO	2/3 yard (60.96cm)
(B) Designer Essentials Solids	Mist	CSFSESS.MISTX	1 3/8 yards (1.26m)
(C) Designer Essentials Solids	Citron	CSFSESS.CITRO	1/4 yard (22.86cm)
(D) Slow & Steady Hexi Pre-cut (42 pc)		FB6HXT.22016	2 packs
(E) Clear Skies	Strawberry Kiwi	PWTP088.STRAW	1/2 yard (45.72cm)*

* includes binding

Backing (Purchased Separately)

44" (121.76cm)			
Pit Crew	Blue	PWTP086.BLUER	2 3/4 yards 2.51m
OR			
108" (274.32cm)			
Free Fall	Sky	QBTP001.SKYXX	1 1/3 yards 1.22m

Additional Requirements

Coats® 100% Cotton Thread

48" x 52" (121.92cm x 130.08cm) batting
 (163) 4 1/4" (10.80cm) English paper pieces
 Iron/pressing board
 Basic hand sewing supplies
 Acid-free glue stick (optional)



(A)

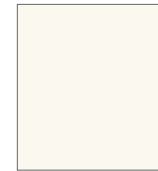

(B)

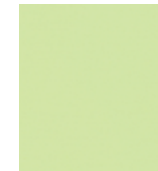

(C)



Hexagon

(D)



(E)



Backing
44"



Backing
108"

Cutting

WOF = width of fabric

Hexagon template provided in the Slow & Steady pack

Fabric A, cut:

(30) 4¾" (12.07cm) hexagons using the template

Fabric B, cut:

(44) 4¾" (12.07cm) hexagons using the template

Fabric C, cut:

(5) 4¾" (12.07cm) hexagons using the template

Fabric D:

Use pre-cut fabric hexagons from the pack

Fabric E, cut:

(5) 2½" x WOF (6.35cm x WOF) strips for the binding

Backing, (for the 44" backing) cut:

(2) 48" x WOF (121.92cm x WOF) strips; sew the strips together and cut (1) 48" x 52" (121.92cm x 130.08cm) rectangle

Sewing and Quilt Top Assembly

- Center one paper hexagon on the wrong side center of a **Fabric A** hexagon. Pin or glue in place. You should have a ¼" (.64cm) of fabric extending evenly around the paper shape (**Fig. 1**).

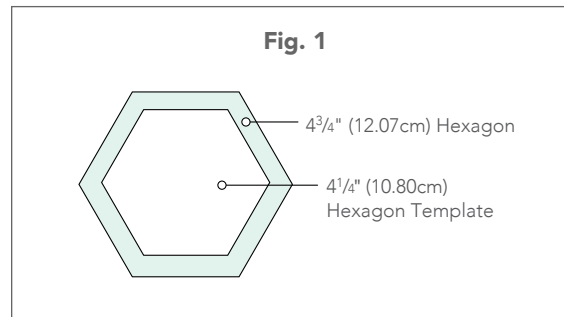

- Fold and baste the fabric around the paper shape. Use a running stitch and go only through the turned-under fabric (not the paper). Continue around the shape, folding sharp points in the corners (**Fig. 2**).

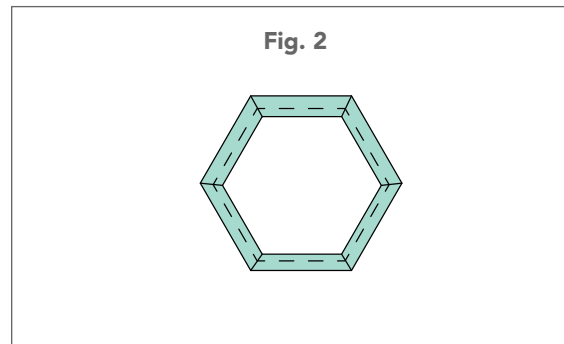

- Repeat steps 1 and 2 with the remaining hexagon papers and fabric hexagons.
- Refer to the Quilt Layout for fabric placement and plan the quilt top. Place two adjacent hexagons right sides together. Using a small whip stitch, sew the two pieces together, being careful to just catch the very edge of each piece with your needle (**Fig. 3**). Do not sew through the paper.

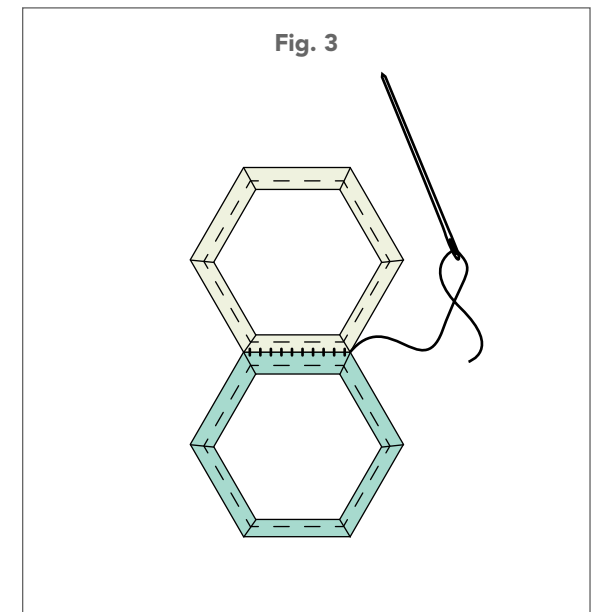

- Once the quilt top has been stitched together, press well and remove the papers.

TIP: The paper pieces can be reused for another quilt if you're careful removing them.

- Trim the quilt top to measure $40\frac{1}{2}'' \times 44\frac{1}{2}''$ (102.87cm x 113.03cm). Depending on the hexagon positioning, the quilt edges can be bias, so handle carefully to avoid distortion.

Finishing

- Layer the backing, batting, and quilt top. Quilt or tie as desired.
- Sew the $2\frac{1}{2}'' \times$ WOF (6.35cm x WOF) **Fabric E** binding strips together end to end using diagonal seams. Press the strip in half lengthwise.
- Carefully trim the backing and batting even with the quilt top.
- Leaving an 8" (20.32cm) tail, sew the binding to top of quilt through all layers matching all raw edges and mitering corners. Stop approximately 12" (30.48cm) from where you started. Lay both loose ends of binding flat along quilt edge. Where these two loose ends meet, fold them back on themselves and press to form a crease. Using this crease as your stitching line, sew the two open ends of the binding together right sides together. Trim the seam to $\frac{1}{4}''$ (.64cm) and press open. Finish sewing the binding to quilt.
- Turn the binding to underside of the quilt and hand-stitch in place.

Quilt Layout

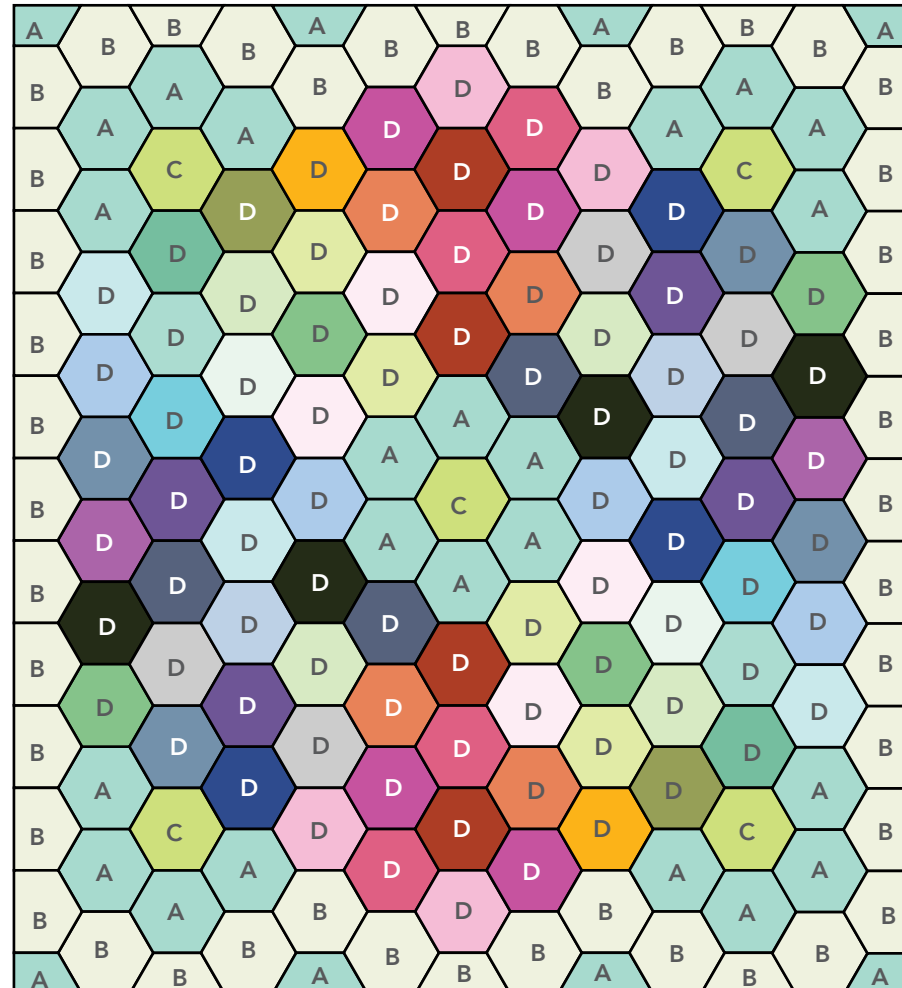

1" (2.54cm)
x
1" (2.54cm)
Square

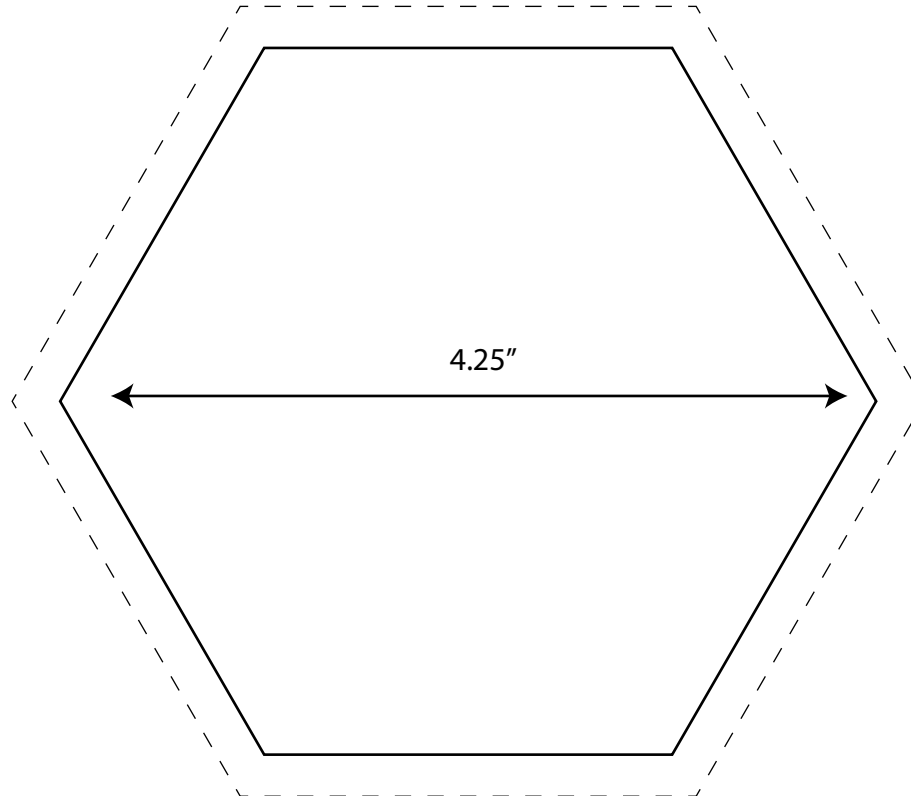

*** Measure templates before cutting to confirm printing at 100%***